

ΗΛΕΚΤΡΙΚΕΣ ΣΥΣΚΕΥΕΣ
ELECTRIC APPLIANCES

Model: INVMS212A

Refrigerator - Freezer
User's Manual

Ψυγείο - Καταψύκτης
Εγχειρίδιο Χρήσης

Σας ευχαριστούμε που επιλέξατε το ψυγείο - καταψύκτη της INVENTOR. Για τη σωστή χρήση της μονάδας, παρακαλούμε διαβάστε προσεκτικά το παρόν εγχειρίδιο και φυλάξτε το για αναφορά στο μέλλον.

Thank you for choosing INVENTOR refrigerator-freezer. For correct use of this unit, please read this manual carefully and keep it for future reference.

English/Ελληνικά/ Română

 **inventor**
Your-conditions

CONTENTS

■ Safety warnings

- Meaning of safety warning symbols2
- Related warnings for use2
- Electricity related warnings2
- Warnings related to placing items3

■ Warnings related to disposal3

Proper use of refrigerators

- Names of components4
- Ice tray (optional)5
- Thermostat5
- Illuminating lamp and replacement5

■ placement5

- Start5

Maintenance of refrigerators

- Cleaning6

■ Defrost6

■ Stop using6

Frequently asked questions

Door install guidelines about swapping left&right

DEAR CUSTOMER:



Thank you for buying this refrigerator-freezer. To ensure that you get the best results from your new refrigerator-freezer, please take time to read through the simple instructions in this booklet. Please ensure that the packing material is disposed of in accordance with the current environmental requirements.

When disposing of any refrigerator-freezer equipment please contact your local waste disposal department for advice on safe disposal.

This appliance must be only used for its intended purpose.

Safety warnings

► Meaning of safety warning symbols

	The symbols indicate prohibited matters, and those behaviors are forbidden. Non-compliance with the instructions may result in product damages or endanger the personal safety of users.
	The symbols indicate matters that must be followed, and those behaviors must be strictly executed in line with the operation requirements. Non-compliance with the instructions may result in product damages or endanger the personal safety of users.
	The symbols indicate matters to pay attention to, and these behaviors shall be specially noted. Due precautions are needed or minor or moderate injuries or damages of the product will be caused.

CAUTION :

The appliance is not intended for use by young children or infirm persons without supervision.

Young children should be supervised to ensure that they do not play with the appliance.

This appliance can be used by children aged from 8 years and above and persons with reduced physical, sensory or mental capabilities or lack of experience and knowledge if they have been given supervision or instruction concerning use of the appliance in a safe way and understand the hazards involved. Children shall not play with the appliance. Cleaning and user maintenance shall not be made by children without supervision.

GENERAL:

This type of refrigerator-freezer is widely used in places such as hotels ,offices, student dormitories and houses. It is mostly suitable for refrigerating and preserving foods such as fruits and beverage. It enjoys the advantages of small size, Lightweight, Low electric consumption and easy use.

This manual contains lots of important safety information which shall be observed by the users.

Safety warnings

► Electricity related warnings

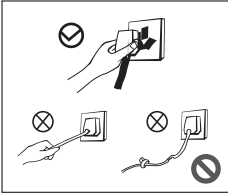

- Do not pull the power cord when pulling the power plug of the refrigerator. Please firmly grasp the plug and pull out it from the socket directly.
- Do not damage the power cord under any condition so as to ensure safety use, do not use when the power cord is damaged or the plug is worn.
- Worn or damaged power cord shall be replaced in manufacture-authorized maintenance stations.

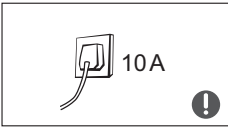

- Please use a dedicated three-hole power socket which is 10A or more and the power socket shall not be shared with other electrical appliances.
- The power cord should be firmly contacted with the socket or else fires might be caused. Please ensure that the grounding electrode of the power socket is equipped with a reliable grounding line.

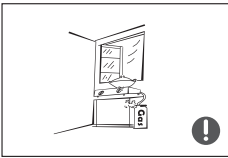

- The refrigerator adopts 220V-240V/50Hz AC power, voltage fluctuations over the range of 187 ~ 242V will cause malfunction or even damage, so a 750 W automatic voltage regulator must be installed in concert with the AC power.
- Please turn off the valve of the leaking gas and then open the doors and windows in case of leakage of gas and other flammable gases. Do not unplug the refrigerator and other electrical appliances considering that spark may cause a fire.

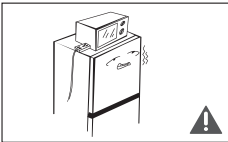

- To ensure safety, it is not recommended that to place regulators, rice cookers, microwave ovens and other appliances at the top of the refrigerator, those recommended by the manufacture are not included. Do not use electrical appliances in the food pantry.

► Related warnings for use

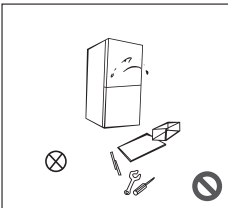

- Authorized demolition or renovation of the refrigerator is not prohibited. It is forbidden to damage the refrigerant lines and the repair and maintenance of the refrigerator must be carried out by professionals.
- Damaged power cord must be replaced by the manufacturer, its maintenance department or related professionals in order to avoid danger.

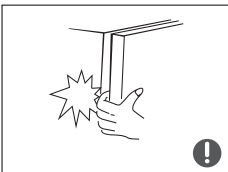

- The surrounding of the appliances around or the embedded structure shall not be obstructed while good ventilation shall be maintained.
- The gaps between refrigerator doors and between doors and refrigerator body are small, be noted not to put your hand in these areas to prevent squeezing the finger. Please be gentle when switching off the refrigerator door to avoid falling articles.
- Do not pick foods or containers in the freezing chamber when the refrigerator is running, especially metal containers in order to avoid frostbite.

Safety warnings



- Do not allow children to enter or climb the refrigerator to prevent that children are sealed in the refrigerator or children are injured by the falling refrigerator.
- Do not spray or wash the refrigerator; do not put the refrigerator in moist places easy to be splashed with water so as not to affect the electrical insulation properties of the refrigerator.

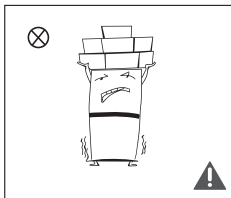

- Do not place heavy objects on the top of the refrigerator considering that objectives may fall when switching the door, and accidental injuries might be caused.
- Please pull of the plug in case of power failure or cleaning. Do not connect the freezer to power supply within five minutes to prevent damages to the compressor due to successive starts.

► Warnings related to placing items

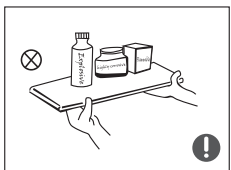

- Do not put flammable, explosive, volatile and highly corrosive items in the refrigerator to prevent damages to the product or fire accidents.
- Do not place flammable items near the refrigerator to avoid fires.

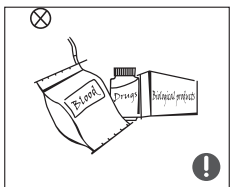

- This product is household refrigerators and shall be only suitable for the storage of foods. According to national standards, household refrigerators shall not be used for other purposes, such as storage of blood, drugs or biological products.



- Do not place items such as bottled or sealed container of fluid such as bottled beers and beverages in the freezer to prevent bursts and other losses.

► Warnings related to disposal

The refrigerator's R600a refrigerant and cyclopentane foam materials are combustible materials and discarded refrigerators should be isolated from fire sources and can not be burned.



Please transfer the freezer to qualified professional recycling companies for processing to avoid damages to the environment or other hazards.



Please remove the door of the refrigerator and shelves which shall be properly placed to avoid accidents of children entering and playing in the refrigerator.

WARNING



Caution:risk of fire

RECOMMENDATIONS

- 1) **WARNING** Keep ventilation openings, in the appliance enclosure or in the built-in structure, clear of obstruction.
- 2) **WARNING** Do not damage the refrigerant circuit.
- 3) **WARNING** Do not use electrical appliances inside the food storage compartments of the appliance, unless they are of the type recommended by the manufacturer.
- 4) The appliance has to be unplugged after use and before carrying out user maintenance on the appliance.
- 5) This appliance is not intended for use by persons (including children) with reduced physical, sensory or mental capabilities, or lack of experience and knowledge, unless they have been given supervision or instruction concerning use of the appliance by a person responsible for their safety.
- 6) Children should be supervised to ensure that they do not play with the appliance.
- 7) If the supply cord is damaged, it must be replaced by the manufacturer, its service agent or similarly qualified persons in order to avoid a hazard.
- 8) Please abandon the refrigerator-freezer according to local regulators for its use flammable blowing gas and refrigerant.
- 9) Please according to local regulations regarding disposal of the appliance for its flammable refrigerant and blowing gas. Before you scrap the appliance, please take off the doors to prevent children trapped.



Correct Disposal of this product

This marking indicates that this product should not be disposed with other household wastes throughout the EU. To prevent possible harm to the environment or human health from uncontrolled waste disposal, recycle it responsibly to promote the sustainable reuse of material resources. To return your used device, please use the return and collection systems or contact the retailer where the product was purchased. They can take this product for environmental safe recycling.

Proper use of refrigerators

► Names of components

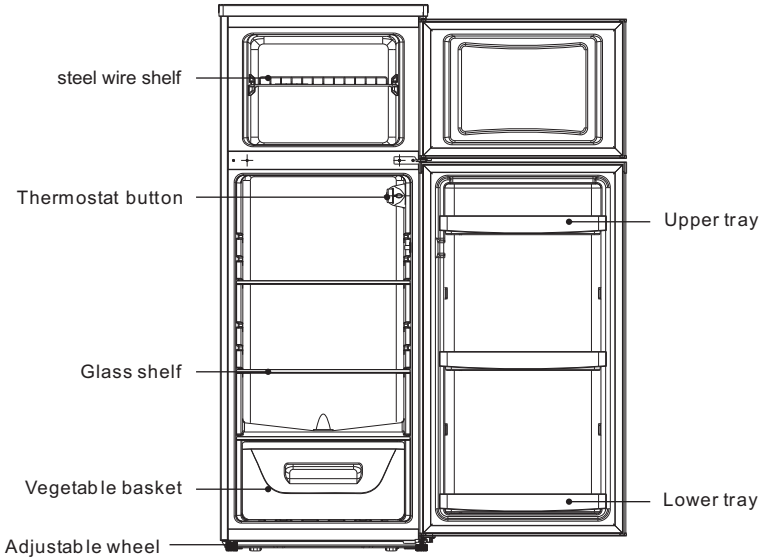

Refrigerating chamber

- The Refrigerating chamber is suitable for storage of a variety of fruits, vegetables, beverages and other food consumed in the short term.
- Cooking foods shall not be put in the refrigerating chamber until cooled to room temperature.
- Foods are recommended to be sealed up before putting into the refrigerator.
- The glass shelves can be adjusted up or down for a reasonable amount of storage space and easy use.

Freezing chamber

- The low temperature freezing chamber may keep food fresh for a long time and it is mainly used to store frozen foods and making ice.
- The freezing chamber is suitable for storage of meat, fish, shrimp, dumplings, rice balls and other foods not to be consumed in short term.
- Chunks of meat are preferably to be divided into small pieces for easy access. Please be noted food shall be consumed within the shelf time.



The features and accessories of the refrigerator you bought may be not entirely consistent with the legend, please refer to the packing list.

Proper use of refrigerators

► Ice tray (optional)

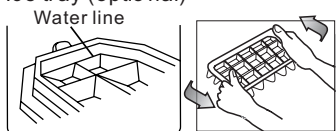

- The ice tray is used for making ice. Boiled water injected to four-fifths of the capacity shall be placed in the refrigerating chamber for about a few hours before forming solid ice, twist the ice tray to separate it from ice.
- Do not bend the ice tray to avoid breakage.

► Thermostat

- The temperature selector knob is located on the right hand side wall of the refrigerator interior
- Setting "Off" : UnitOff
- Setting "Min" : Less Cool Temperature
- Setting "Med" : Normal Operation(adequate for most situations)
- Setting "Max" : Coolest Temperature
- During high ambient temperatures e.g. on hot summer days. It may be necessary to set the thermostat to the Coolest setting(positionMax). This may cause the compressor running continuously in order to maintain a low temperature in the cabinet.
- **For the first time you install your refrigerator, set the thermostat knob at "Med" .** Give your refrigerator time to cool down completely before adding food. It is the best to wait 24 hours before adding food. The thermostat knob controls the temperature. When the thermostat control knob is set to **OFF**, the refrigerator will not be running.

► Illuminating lamp and replacement

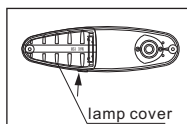

- Illuminating lamp parameter: MAX15W
- Lighting lamps replacement:
First unplug the refrigerator-freezer.
As specified in the drawing, first remove the lighting lampshade on the arrow, and then replace the bulb.

► Placement

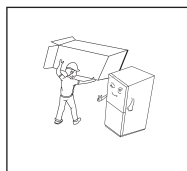

- Before using the refrigerator, remove all packaging materials including bottom cushions and foam pads and tapes inside the refrigerator, tear off the protective film on the door and the refrigerator body.

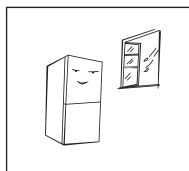

- The refrigerator is placed in a well-ventilated indoor place; the ground shall be flat, and sturdy (rotate left or right to adjust the wheel for leveling if unstable).

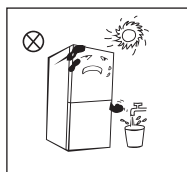

- Keep away from heat and avoid direct sunlight. Do not place the freezer in moist or watery places to prevent rust or reduction of insulating effect.

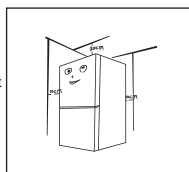

- The top space of the refrigerator shall be greater than 30cm, and the distances from both sides and backside shall be more than 10 cm to facilitate the opening and closing and heat dissipation.
- Wipe the refrigerator inside and outside with warm moist rag (add a small amount of detergent in the warm water and wipe clean finally with clean water).

► Start

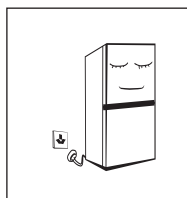

- The refrigerator shall stay for half an hour before connecting 220-240V/50Hz power when it is firstly started.
- The refrigerator shall run 2 to 3 hours before loading fresh or frozen foods; the refrigerator shall run for more than 4 hours in summer in advance considering that the ambient temperature is high.

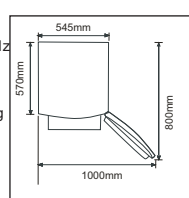

- Please leave enough space to ensure feasible opening and drawer removal.
- Dimensions shown are for reference only.

Maintenance of refrigerators

► Cleaning

- Dusts behind the refrigerator and on the ground shall be timely cleaned to improve the cooling effect and energy saving. The interior of the refrigerator should be cleaned regularly to avoid odor. Soft towels or sponge dipped in water and non-corrosive neutral detergents are suggested for cleaning. The freezer of shall be finally cleaned with clean water and dry cloth. Open the door for natural drying before the power is turned on.



- Do not use hard brushes, clean steel balls, wire brushes, abrasives, such as toothpastes, organic solvents (such as alcohol, acetone, banana oil, etc.), boiling water, acid or alkaline items clean refrigerator considering that this may damage the fridge surface and interior.
- Do not rinse with water so as not to affect the electrical insulation properties. Please use a dry cloth when cleaning lighting lamps, temperature control knob and electrical components.

⚠ Please unplug the refrigerator for defrost and cleaning.

► Defrost

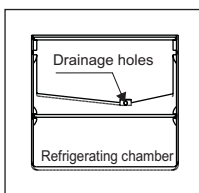

- Manual defrost of freezer is not needed. The frost on the posterior wall frosting will melt and outflow through the drainage holes to refrigerator intraday for automatic evaporation.
- Freezing chamber shall be manually defrosted. A layer of frost will be formed on the evaporator plate after a period of operation. If the frost layer is too thick, the power consumption will be increased and cooling effect will be impacted; defrost and cleaning are needed when a thick layer of ice is formed on the evaporator plate. Please put a bowl of hot water in the freezing chamber to accelerate defrosts, and the defrosting water shall be dried with dry cloth.

⚠ Do not use metal utensils or electric heater for defrost so as not to damage the appliance. Please remove the food and put in a cool place when defrosting before removing drawers and other accessories.

► Stop using

Foods can be preserved for a couple of hours even in summer in case of power failure; it is recommended to reduce the frequency of opening door and do not put fresh foods into the freezer.

Please unplug the refrigerator left unused for a long time for cleaning. Keep the door open to avoid the bad odor.

Before moving the refrigerator, please remove all items in the refrigerator and fasten the glass partitions, fruit and vegetable boxes, freezer drawers with taps lest the door opens during displacement; Do not turn upside, horizontally place or vibrate the refrigerator, the carrying angle can not be greater than 45 °C.

⚠ Continuous operation is recommended when the refrigerator is started. Please do not move the refrigerator under normal circumstances so as not to affect the refrigerator's service life.

Frequently asked questions

- The following simple issues can be handled by the user. Please call the after-sale service department if the issues are not settled.

Inoperation	Whether the freezer is plugged and connected to power; Low voltage; Failure power or tripping circuit
Odor	Odorous foods should closely wrapped; Whether foods are rotten; Whether the interior shall be cleaned.
Foods in the refrigerating chamber are frozen	Whether the thermostat is over adjusted; Whether foods containing water is put in inside the glass partition.
Long-term operation of compressor	It is normal that refrigerator operates for longer time in summer when the ambient temperature is higher; Do not put too much food in the freezer at one time; Do not put foods until they are cooled; Frequent opening of refrigerator door. Thick frost layer (defrost is needed)
Illuminating light does not shine	Whether the refrigerator is connected to power, whether the illuminating light is damaged.
The refrigerator door can not be properly closed.	The freezer door is stuck by food packages; Too much food; Tilt refrigerator.
Loud noises	Whether the food is leveled, whether the refrigerator is balanced; Whether the refrigerator parts are properly placed.

Warm tips:

- ◆ The refrigerator enclosure may emit heat during operation specially in summer, this is caused by the radiation of the condenser, and it is a normal phenomenon.
- ◆ Condensation: condensation phenomenon will be detected on the exterior surface and door seals of the freezer when the ambient humidity is large, this is a normal phenomenon, and the condensation can be wiped away with a dry towel.
- ◆ Airflow sound: Refrigerants circulating in the refrigerant lines will produce eruption of sound and grunts which is normal does not affect the cooling effect.
- ◆ Buzz: Buzz will be generated by running compressor specially when starting up or shutting down.
- ◆ Clatter: The solenoid valve or electric switch valve will clatter which is a normal phenomenon and does not affect the operation.
- ◆ The refrigerating chamber will periodically frost and defrost (water drops will be generated on the backside of the refrigerating chamber when defrosting) which are normal.

Door install guidelines about swapping left&right

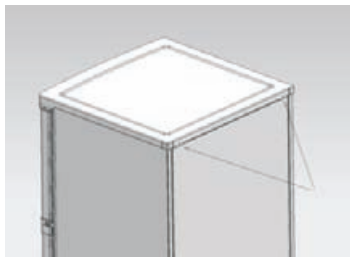

1.Remove the 2 screws fixed cover, remove the top cover.

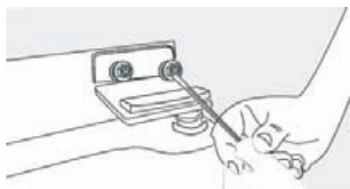

2. Remove the 2 screws fixed on the hinge.

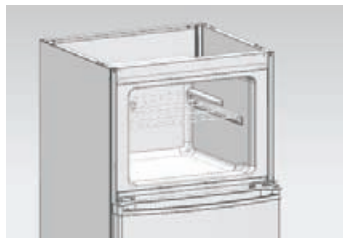

3. Remove the door.



4.2 screws to remove the fixed hinge, remove the door.

Door install guidelines about swapping left&right

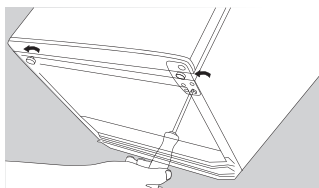

5. Undo the screws and remove the hinge bracket from the base. A spanner may be required to loosen the bolts first. Remove the Hinge Pin and re-position it into the location on the opposite side.

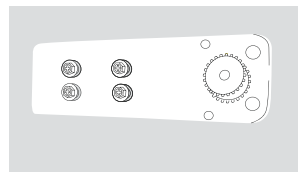

Remove the screws and adjustable foot from the opposite side and fit back to where the hinge bracket was located.

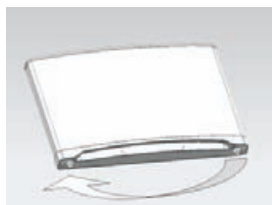

6 Will come under the threshold, a change from side to the other side.

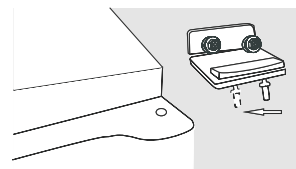

7. Undo the pin at right hole of top hinge and fix it at the left hole, as the arrow indicated.

8 Will the door, the door sleeve from the side of the replacement to the other side

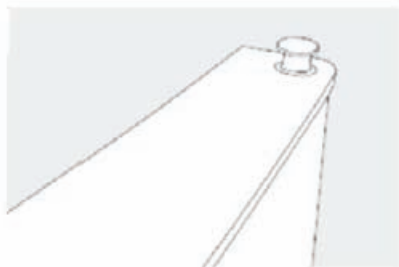

Door install guidelines about swapping left&right

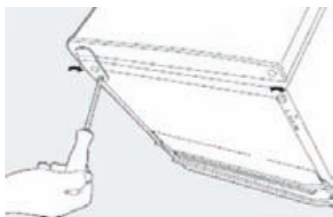

9. Install hinge on the other side, fixed with screw tight.



10. Install hinge door and fixed by screws tight.

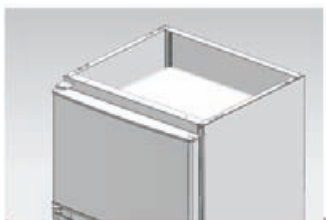

11. Install the door and the hinge, screws tight.

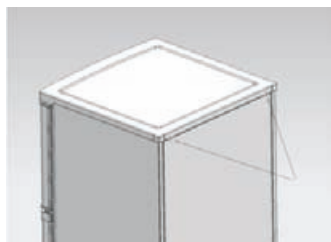

12. Install cover.

ΠΕΡΙΕΧΟΜΕΝΑ

■ Οδηγίες ασφαλείας

Σύμβολα οδηγιών ασφαλείας	2
Σχετικές οδηγίες για τη χρήση	2
Οδηγίες ασφαλείας σχετικά με το ρεύμα	2
Οδηγίες ασφαλείας σχετικά με την τοποθέτηση αντικειμένων	3
Οδηγίες ασφαλείας σχετικά με την απόρριψη της συσκευής	3

■ Σωστή χρήση των ψυγείων

Περιγραφή εξαρτημάτων	4
Παγοθήκη (προαιρετικά)	5
Θερμοστάτης	5
Ενδεικτικές λυχνίες και αντικατάσταση αυτών	5
Τοποθέτηση	5
Εκκίνηση λειτουργίας	5

■ Συντήρηση των ψυγείων

Καθαρισμός	6
Απόψυξη	6
Διακοπή λειτουργίας	6

■ Συχνές ερωτήσεις

■ Οδηγίες τοποθέτησης της πόρτας δεξιά και αριστερά

ΑΓΑΠΗΤΕ ΧΡΗΣΤΗ:

Σας ευχαριστούμε που επιλέξατε αυτόν τον ψυγείο-καταψύκτη. Για την διασφάλιση της βέλτιστης λειτουργίας του νέου σας ψυγείο-καταψύκτη, παρακαλούμε διαβάστε πρώτα τις οδηγίες που περιέχονται σε αυτό το εγχειρίδιο. Βεβαιωθείτε πως η απόρριψη της συσκευασίας έχει γίνει σύμφωνα με τους κανονισμούς. Κατά τη απόρριψη του ψυγείο-καταψύκτη επικοινωνήστε με τις τοπικές αρχές για τη σωστή απόρριψη του προϊόντος. Η συσκευή αυτή δεν πρέπει να χρησιμοποιείται για άλλους σκοπούς.

Οδηγίες ασφαλείας

► Περιγραφή συμβόλων οδηγιών ασφαλείας



Σύμβολα απαγόρευσης

Αυτά τα σύμβολα υποδεικνύουν απαγορεύσεις. Εάν δεν ακολουθηθούν οι συγκεκριμένες οδηγίες μπορεί να προκληθεί βλάβη της μονάδας ή τραυματισμός του χρήστη.



Σύμβολα προειδοποίησης

Αυτά τα σύμβολα υποδεικνύουν πως πρέπει να ακολουθηθούν οι συγκεκριμένες οδηγίες παράλληλα με τις οδηγίες λειτουργίας. Εάν δεν ακολουθηθούν οι συγκεκριμένες οδηγίες μπορεί να προκληθεί βλάβη στη μονάδα ή τραυματισμός του χρήστη.



Σύμβολα προσοχής

Αυτά τα σύμβολα υποδεικνύουν οδηγίες στις οποίες πρέπει να δοθεί ιδιαίτερη προσοχή. Σε αντίθετη περίπτωση μπορεί να προκληθούν τραυματισμοί ή βλάβη στη μονάδα

ΠΡΟΣΟΧΗ:

Αυτή η συσκευή δεν πρέπει να χρησιμοποιείται από μικρά παιδιά ή άτομα με ειδικές ανάγκες χωρίς επίβλεψη.

Τα μικρά παιδιά θα πρέπει να επιβλέπονται ώστε να μην παίζουν με τη μονάδα

Αυτή η συσκευή μπορεί να χρησιμοποιηθεί από παιδιά πάνω από 8 ετών και άτομα με ειδικές ανάγκες εφόσον επιβλέπονται από άτομα υπεύθυνα για την ασφάλειά τους. Μην επιτρέπετε στα παιδιά να παίζουν με τη συσκευή. Ο καθαρισμός δεν πρέπει να γίνεται από παιδιά, εκτός αν επιβλέπονται.

ΓΕΝΙΚΕΣ ΟΔΗΓΙΕΣ:

Αυτός ο τύπος ψυγείο-καταψύκτη χρησιμοποιείται σε μέρη όπως ξενοδοχεία, γραφεία, φοιτητικές εστίες και σπίτια. Είναι κατάλληλο κυρίως για τη ψύξη και συντήρηση τροφίμων όπως φρούτα και λαχανικά. Έχει μικρό μέγεθος, είναι ελαφρύ, χαμηλής κατανάλωσης ενέργειας και εύκολο στη χρήση.

Αυτό το εγχειρίδιο περιέχει σημαντικές οδηγίες ασφαλείας για τους χρήστες.

Οδηγίες ασφαλείας

► Οδηγίες ασφαλείας σχετικά με το ρεύμα

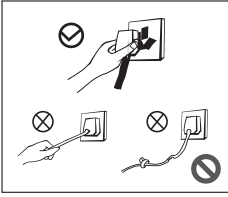

- Όταν θέλετε να αφαιρέσετε το φισ από τη πρίζα μην τραβάτε το καλώδιο. Πιάστε σφιχτά το φισ και αφαιρέστε το από την πρίζα.
- Για την ασφαλή λειτουργία βεβαιωθείτε πως δεν υπάρχει φθορά στο καλώδιο ή στην πρίζα.
- Ένα φθαρμένο καλώδιο πρέπει να αντικατασταθεί από εξειδικευμένο προσωπικό.

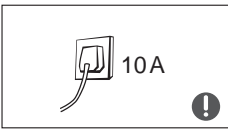

- Χρησιμοποιήστε τριπολική πρίζα τουλάχιστον των 10A και βεβαιωθείτε πως δεν χρησιμοποιείται και για άλλες συσκευές.
- Το φισ του καλωδίου πρέπει να είναι σφιχτά τοποθετημένο στην πρίζα, αλλιώς μπορεί να προκληθεί πυρκαγιά. Βεβαιωθείτε πως η πρίζα είναι σωστά γειωμένη.



- Ο καταψύκτης λειτουργεί με ρεύμα 220-240V/50Hz. Διακυμάνσεις πάνω από 187-242V θα προκαλέσουν δυσλειτουργία ή ακόμα και βλάβη στον καταψύκτη. Επομένως θα πρέπει να τοποθετηθεί ένας ρυθμιστής τάσης 750W.
- Κλείστε τη βάνα αερίου και ανοίξτε πόρτες και παράθυρα σε περίπτωση διαρροής αερίου ή άλλων ευφλεκτων αερίων. Μην βγάξετε από την πρίζα τον καταψύκτη ή άλλες συσκευές διότι μια σπίθα μπορεί να προκαλέσει φωτιά.

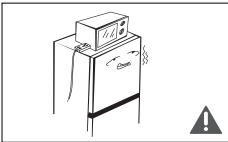

- Μην τοποθετείτε μαγειρικά σκεύη, φούρνους μικροκυμάτων ή άλλες συσκευές πάνω στο ψυγείο. Μην τοποθετείτε ηλεκτρικές συσκευές στον θάλαμο τροφίμων.

► Οδηγίες ασφαλείας σχετικά με τη χρήση

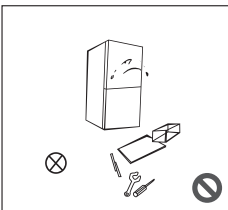

- Οποιαδήποτε επισκευή ή αλλαγή από εξειδικευμένο προσωπικό δεν απαγορεύεται. Απαγορεύεται η φθορά των ψυκτικών σωληνώσεων και οποιαδήποτε επισκευή ή συντήρηση πρέπει να γίνεται από εξειδικευμένο προσωπικό.
- Φθαρμένο καλώδιο τροφοδοσίας πρέπει να αντικαθίσταται από τον κατασκευαστή ή εξειδικευμένο προσωπικό για την αποφυγή τραυματισμών.

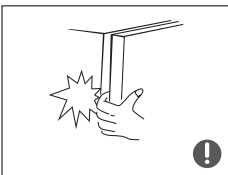

- Θα πρέπει να υπάρχει επαρκής χώρος γύρω από τον ψυγείο - καταψύκτη και να υπάρχει επαρκής εξαερισμός.
- Τα διάκενα ανάμεσα στην πόρτα και το σώμα του ψυγείου είναι πολύ μικρά. Επομένως μην τοποθετείτε τα χέρια σας σε αυτές τις περιοχές για να μην "πιαστούν" τα δάχτυλά σας. Μην κλείνετε απότομα την πόρτα του ψυγείου, μπορεί να ποσυναρμολογηθούν εξαρτήματα.
- Μην ανοίγετε τρόφιμα ή συσκευασίες μέσα στον θάλαμο του ψυγείου όταν αυτός λειτουργεί.

Οδηγίες ασφαλείας



- Μην επιτρέπετε στα παιδιά να ανεβαίνουν ή να μπáινουν μέσα στο ψυγείο. Υπάρχει κίνδυνος να κλειδωθούν μέσα ή να πέσουν από το ψυγείο.
- Μην ρίχνετε νερό στο ψυγείο και μην το τοποθετείτε σε μέρη με υψηλή υγρασία, διότι υπάρχει κίνδυνος φθοράς της ηλεκτρικής μόνωσης του.

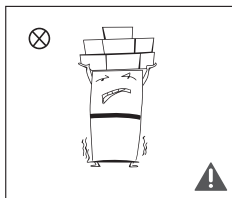

- Μην τοποθετείτε βαριά αντικείμενα πάνω στο ψυγείο, διότι υπάρχει κίνδυνος πτώσης κατά το κλείσιμο της πόρτας και να προκληθεί τραυματισμός.
- Να αφαιρείτε το καλώδιο από την πρίζα σε περίπτωση διακοπής ρεύματος ή κατά τον καθαρισμό του ψυγείου. Μην επανασυνδέετε το ψυγείο στην πρίζα αν δεν παρέλθουν τουλάχιστον 5 λεπτά, για την αποφυγή βλάβης του συμπιεστή.

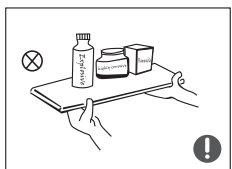

- Μην τοποθετείτε εύφλεκτα, εκρηκτικά, ασταθή και διαβρωτικά αντικείμενα μέσα στο ψυγείο, για την αποφυγή βλάβης του ψυγείου ή πυρκαγιάς.
- Μην τοποθετείτε εύφλεκτα υλικά κοντά στο ψυγείο, για την αποφυγή πυρκαγιάς.

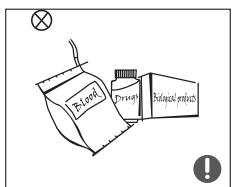

- Αυτό το προϊόν είναι ψυγείο οικιακής χρήσης και πρέπει να χρησιμοποιείται μόνο για την αποθήκευση τροφίμων. Σύμφωνα με τους εθνικούς κανονισμούς τα οικιακής χρήσης ψυγεία δεν πρέπει να χρησιμοποιούνται για άλλους σκοπούς όπως αποθήκευση αίματος, φαρμάκων ή βιολογικών προϊόντων.



- Μην τοποθετείτε στο ψυγείο υγρά σφραγισμένα ή σε μπουκάλια, όπως μπίρες και αναψυκτικά, για την αποφυγή σπασίματος ή άλλων απωλειών.

► Οδηγίες ασφαλείας σχετικά με την απόρριψη της συσκευής



Το ψυγείο περιέχει R600a ψυκτικό υγρό και υλικά τα οποία είναι εύφλεκτα. Τα ψυγεία που είναι προς απόρριψη δεν πρέπει να βρίσκονται κοντά σε πηγές θερμότητας και δεν μπορείτε να τα κάψετε. Παρακαλούμε μεταφέρετε το ψυγείο σε ειδικούς οργανισμούς ανακύκλωσης για την αποφυγή καταστροφής του περιβάλλοντος.



Αφαιρέστε την πόρτα και τα ράφια του ψυγείου και τοποθετήστε σε κατάλληλο μέρος ώστε να απφευχθούν πιθανοί τραυματισμοί παιδιών τα οποία μπορεί να παίζουν με το ψυγείο.

ΠΡΟΕΙΔΟΠΟΙΗΣΗ



Προσοχή: Κίνδυνος πυρκαγιάς

ΥΠΟΔΕΙΞΕΙΣ

- 1) ΠΡΟΕΙΔΟΠΟΙΗΣΗ Βεβαιωθείτε πως υπάρχει επαρκής αερισμός του χώρου και δεν υπάρχουν εμπόδια γύρω από τη συσκευή.
- 2) ΠΡΟΕΙΔΟΠΟΙΗΣΗ Βεβαιωθείτε πως δεν προκαλείται φθορά στο ψυκτικό κύκλωμα.
- 3) ΠΡΟΕΙΔΟΠΟΙΗΣΗ Μην χρησιμοποιείτε ηλεκτρικές συσκευές στους θαλάμους αποθήκευσης τροφίμων, εκτός αν προδιαγράφονται από τον κατασκευαστή.
- 4) Το ψυγείο θα πρέπει να αποσυνδέεται από την παροχή ρεύματος όταν δεν θα χρησιμοποιηθεί για αρκετό χρονικό διάστημα και πριν τις εργασίες συντήρησης.
- 5) Αυτή η συσκευή δεν πρέπει να χρησιμοποιείται από άτομα με ειδικές ανάγκες, άτομα με έλλειψη εμπειρίας ή γνώσης και παιδιά, εκτός αν επιβλέπονται από άτομα υπεύθυνα για την ασφάλεια τους και μπορούν να τους καθοδηγήσουν.
- 6) Τα παιδιά θα πρέπει να επιβλέπονται ώστε να μην παίζουν με τη συσκευή.
- 7) Εάν φθαρεί το καλώδιο τροφοδοσίας, θα πρέπει να αντικατασταθεί είτε από τον κατασκευαστή είτε από εξειδικευμένο προσωπικό για την αποφυγή τραυματισμού.
- 8) Η απόρριψη του ψυγείο-καταψύκτη θα πρέπει να γίνεται σύμφωνα με τους εθνικούς κανονισμούς διότι περιέχει εύφλεκτο ψυκτικό υγρό.
- 9) Να ακολουθείτε τους τοπικούς κανονισμούς για την απόρριψη της συσκευής λόγω των εύφλεκτων αερίων και ψυκτικού υγρού που περιέχει. Πριν την απόρριψη της συσκευής να αφαιρείτε τις πόρτες διότι υπάρχει κίνδυνος εγκλωβισμού κάποιου παιδιού που μπορεί να παίζει με αυτή.



Σωστή απόρριψη του συγκεκριμένου προϊόντος

Αυτό το σύμβολο υποδεικνύει πως αυτό το προϊόν δεν πρέπει να απορρίπτεται μαζί με τα αστικά λύματα. Για την προστασία του περιβάλλοντος και την ανθρώπινη υγεία, να ανακυκλώνετε αυτά τα προϊόντα. Για περισσότερες πληροφορίες σε ότι αφορά την ανακύκλωση μπορείτε να απευθυνθείτε σε ειδικούς οργανισμούς ή επικοινωνήστε με τον προμηθευτή σας. Έχουν τη δυνατότητα να παραλάβουν αυτό το προϊόν προς ανακύκλωση.

Σωστή χρήση των ψυγείων

► Περιγραφή εξαρτημάτων

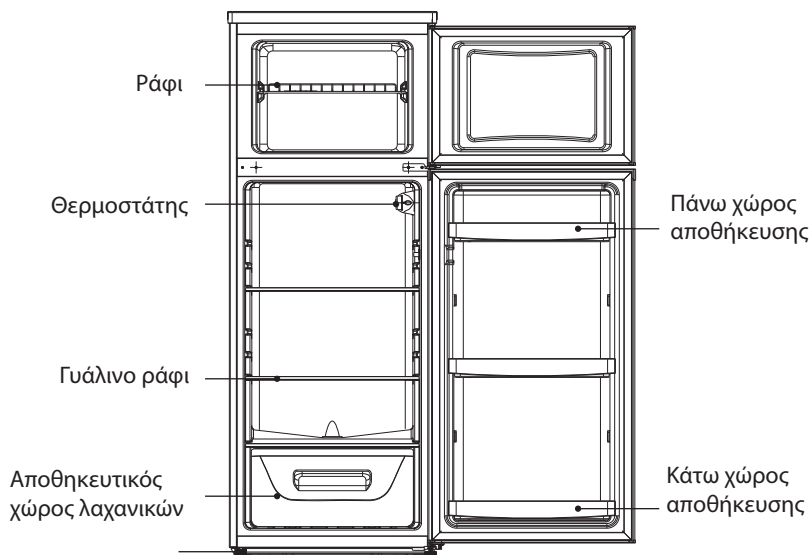

Θάλαμος ψύξης

- Ο θάλαμος ψύξης είναι κατάλληλος για την αποθήκευση φρούτων, λαχανικών, αναψυκτικών και άλλων τροφίμων που καταναλώνονται σε σύντομο χρονικό διάστημα.
- Πριν τοποθετήσετε μαγειρεμένα τρόφιμα στον θάλαμο θα πρέπει πρώτα να τα έχετε αφήσει να κρυσώσουν.
- Τα τρόφιμα πριν τοποθετηθούν στον θάλαμο θα πρέπει να σφραγίζονται.
- Τα γυάλινα ράφια μπορούν να προσαρμοστούν πάνω ή κάτω για να υπάρχει επάρκεια χώρου και ευκολία στη χρήση.

Θάλαμος κατάψυξης

- Ο θάλαμος κατάψυξης διατηρεί φρέσκα τα τρόφιμα για αρκετό χρονικό διάστημα και συνήθως χρησιμοποιείται για την αποθήκευση κατεψυγμένων τροφίμων και για παγάκια.
- Ο θάλαμος της κατάψυξης είναι κατάλληλος για την αποθήκευση κρέατος, ψαριών, θαλασσινών, ζυμαρικών και άλλων τροφίμων που δεν θα καταναλωθούν σε σύντομο χρονικό διάστημα.
- Το κρέας καλό θα ήταν να το χωρίζετε σε μικρές μερίδες για ευκολότερη πρόσβαση. Να σημειωθεί ότι τα τρόφιμα θα πρέπει να καταναλωθούν πριν την ημερομηνία λήξης.



Η εμφάνιση και τα εξαρτήματα του καταψύκτη που προμηθευτήκατε μπορεί να διαφέρουν από το υπόμνημα, ανατρέξτε στην αντίστοιχη λίστα.

Σωστή χρήση των ψυγείων

► Παγοθήκη (προαιρετικά)

Γραμμή ορίου νερού

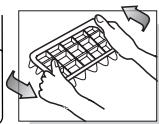
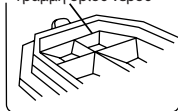

- Η παγοθήκη χρησιμοποιείται για παγάκια. Γεμίστε με νερό τα τέσσερα πέμπτα της χωρητικότητας και τοποθετήστε την παγοθήκη στον θάλαμο της κατάψυξης για μερικές ώρες. Στρέψτε την παγοθήκη για να διαχωρίσετε τα παγάκια.
- Μην λυγίζετε την παγοθήκη, διότι μπορεί να σπάσει.

► Θερμοστάτης

- Ο θερμοστάτης είναι τοποθετημένος στη δεξιά πλευρά του θαλάμου
- Ρύθμιση OFF: Το ψυγείο δεν λειτουργεί
- Ρύθμιση Min: Μικρότερη θερμοκρασία ψύξης
- Ρύθμιση Med: Κανονική λειτουργία (κατάλληλη για τις περισσότερες περιπτώσεις)
- Ρύθμιση Max: Μέγιστη θερμοκρασία ψύξης
- Στις περιόδους με υψηλή θερμοκρασία περιβάλλοντος π.χ. τις ζεστές μέρες του καλοκαιριού, μπορεί να χρειαστεί να θέσετε τον θερμοστάτη στην μέγιστη ρύθμιση. Αυτό θα έχει ως αποτέλεσμα τη συνεχή λειτουργία του συμπιεστή ώστε να διατηρείται η χαμηλή θερμοκρασία στον θάλαμο.
- Κατά την πρώτη εκκίνηση λειτουργίας του ψυγείου σας, θέστε τον θερμοστάτη στη θέση Med. Αφήστε το ψυγείο να λειτουργεί για 24 ώρες πριν τοποθετήσετε τρόφιμα στους θαλάμους. Ο θερμοστάτης ελέγχει τη θερμοκρασία. Όταν ο θερμοστάτης είναι σε θέση OFF, το ψυγείο δεν θα λειτουργεί.

► Ενδεικτικές λυχνίες και αντικατάσταση αυτών

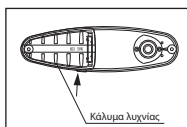

Κάλυμμα λυχνίας

- Χαρακτηριστικά ενδεικτικής λυχνίας: 15W μέγιστο
- Αντικατάσταση ενδεικτικών λυχνιών:
Όπως φαίνεται στο σκαρφήμα, αφαιρέστε το κάλυμμα όπως δείχνει το βέλος και αντικαταστήστε τη λυχνία.

► Τοποθέτηση

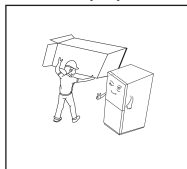

- Πριν χρησιμοποιήσετε το ψυγείο, αφαιρέστε όλα τα υλικά συσκευασίας συμπεριλαμβανομένων των βάσεων και των ταινιών που βρίσκονται στο εσωτερικό του ψυγείου. Αφαιρέστε το προστατευτικό φιλμ από την πόρτα και το σώμα του ψυγείου.

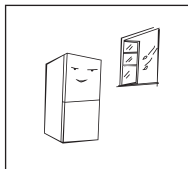

- Το ψυγείο θα πρέπει να τοποθετηθεί σε έναν χώρο με καλό εξαερισμό και σε επίπεδο έδαφος (αν δεν είναι σταθερό γυρίστε το δεξιά ή αριστερά για να το προσαρμόσετε).

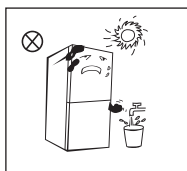

- Βεβαιωθείτε πως δεν βρίσκεται κοντά σε πηγές θερμότητας και αποφύγετε την απευθείας ηλιακή ακτινοβολία. Μην τοποθετείτε το ψυγείο σε μέρος με υψηλή υγρασία, για την αποφυγή εμφάνισης σκουριάς ή φθοράς της μόνωσης.

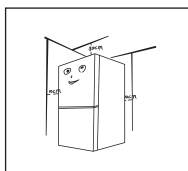

- Η απόσταση από το πάνω μέρος του καψύκτη πρέπει να είναι μεγαλύτερη από 30cm και οι αποστάσεις στο πλάι και πίσω πρέπει να είναι μεγαλύτερες από 10cm για ευκολότερο ανοιγοκλείσιμο της πόρτας και ευκολότερης έκλυσης θερμότητας.

- Καθαρίστε το εσωτερικό του ψυγείου με ένα βρεγμένο πανί (προσθέστε σε ζεστό νερό μικρή ποσότητα απορρυπαντικού για τον καθαρισμό και έπειτα χρησιμοποιήστε καθαρό νερό)

► Εκκίνηση λειτουργίας

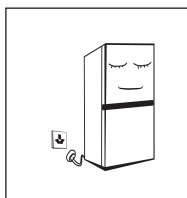

- Πριν την πρώτη εκκίνηση περιμένετε μισή ώρα και μετά συνδέστε την παροχή ρεύματος 220-240V/50Hz.
- Πριν τοποθετήσετε φρέσκα ή κατεψυγμένα τρόφιμα θα πρέπει ο καταψύκτης να είναι σε λειτουργία 2 με 3 ώρες και το καλοκαίρι, λόγω του ότι η θερμοκρασία περιβάλλοντος είναι υψηλότερη, πάνω από 4 ώρες.

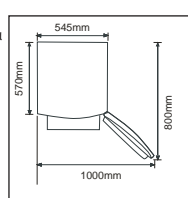

- Βεβαιωθείτε πως υπάρχει επαρκής ελεύθερος χώρος για το άνοιγμα της πόρτας και του συρταριού.
- Οι διαστάσεις που φαίνονται στην εικόνα είναι αναφορικές.

Συντήρηση των ψυγείων

► Καθαρισμός

- Η σκόνη που εμφανίζεται πίσω από το ψυγείο και το έδαφος θα πρέπει να καθαρίζεται συχνά για την βελτίωση της ψυκτικής απόδοσης και για εξοικονόμηση ενέργειας. Το εσωτερικό του ψυγείου θα πρέπει να καθαρίζεται συχνά για την αποφυγή οσμών. Για τον καθαρισμό προτινείται είτε βρεγμένο πανί σε νερό είτε ουδέτερα απορρυπαντικά. Ο καθαρισμός θα πρέπει να ολοκληρώνεται με καθαρό νερό και στεγνό πανί. Ανοίξτε την πόρτα για να στεγνώσει το εσωτερικό και έπειτα επανα συνδέστε το στην παροχή ρεύματος.



- Μην χρησιμοποιείτε σκληρά υλικά ή στιλβωτικά, όπως οδοντόπαστα, οργανικά διαλύματα (όπως οινόπνευμα, ασετό κλπ), καυτό νερό, οξέα ή αλκαλικά διαλύματα για τον καθαρισμό του ψυγείου, διότι μπορεί να προκληθεί φθορά στην επιφάνεια και το εσωτερικό του.
- Μην ρίχνετε νερό για τον καθαρισμό διότι μπορεί να προκληθεί φθορά στην μόνωση του ψυγείου. Να χρησιμοποιείτε στεγνό πανί για τον καθαρισμό του θερμοστάτη και των ηλεκτρικών μερών.

⚠ Για την αποψυξη και τον καθαρισμό να αποσυνδέετε το ψυγείο από την παροχή ρεύματος.

► Απόψυξη

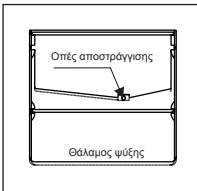

- Το ψυγείο δεν χρειάζεται χειροκίνητη απόψυξη. Ο πάγος που σχηματίζεται στα τοιχώματα θα λιώσει και μέσω των οπών αποστράγγισης θα απομακρυνθεί και θα εξατμιστεί.
- Η απόψυξη του θαλάμου κατάψυξης γίνεται χειροκίνητα. Μετά από κάποιο χρονικό διάστημα λειτουργίας σχηματίζεται ένα στρώμα πάγου. Εάν είναι πολύ παχύ, θα αυξηθεί η κατανάλωση ενέργειας και θα επηρεαστεί η ψυκτική ικανότητα. Όταν σχηματίζεται ένα παχύ στρώμα πάγου χρειάζεται να γίνει απόψυξη και καθαρισμός. Για την ταχύτερη απόψυξη μπορείτε να τοποθετήσετε στον θάλαμο ένα δοχείο με καυτό νερό και καθαρίστε το νερό με ένα στεγνό πανί.

⚠ Μην χρησιμοποιείτε μεταλλικά αντικείμενα ή ηλεκτρικά θερμαντικά αντικείμενα για την απόψυξη, διότι θα προκληθεί φθορά στη συσκευή. Πριν αφαιρέσετε τα συρτάρια και άλλα εξαρτήματα, αφαιρέστε τα τρόφιμα και τοποθετήστε τα σε δροσερό μέρος.

► Διακοπή λειτουργίας

Κατά τη διάρκεια διακοπής ρεύματος τα τρόφιμα μπορούν να διατηρηθούν για μερικές ώρες ακόμα και το καλοκαίρι. Να αποφεύγεται το συχνό άνοιγμα της πόρτας και μην τοποθετείτε φρέσκα τρόφιμα στο ψυγείο.

Όταν το ψυγείο δεν θα χρησιμοποιηθεί για αρκετό χρονικό διάστημα, αποσυνδέστε το από την παροχή ρεύματος, καθαρίστε το και αφήστε ανοιχτή την πόρτα για την αποφυγή εμφάνισης άσχημων οσμών.

Πριν μετακινήσετε το ψυγείο, αφαιρέστε όλα τα τρόφιμα από τον θάλαμο, ασφαλίστε τα ράφια και τα συρτάρια με ταινίες σε περίπτωση που η ανοίξει η πόρτα κατά τη μεταφορά. Μην γυρνάτε ανάποδα , τοποθετείτε οριζόντια ή δημιουργείτε κραδασμούς στο ψυγείο. Η γωνία μεταφοράς δεν πρέπει να είναι πάνω από 45 μοίρες.

⚠ Όταν εκκινήσετε το ψυγείο, συστήνεται η συνεχής λειτουργία του. Μην μετακινείτε το ψυγείο υπό κανονικές συνθήκες, ώστε να μην επηρεαστεί η διάρκεια ζωής του.

Συχνές ερωτήσεις

- Τα παρακάτω απλά θέματα μπορεί να επιλυθούν από τον χρήστη. Εάν το πρόβλημα παραμένει επικοινωνήστε με τον προμηθευτή σας.

Το ψυγείο δεν λειτουργεί	Ελέγξτε εάν ο καταψύκτης είναι συνδεδεμένος με την παροχή ρεύματος. Χαμηλή τάση. Ελέγξτε ότι ο θερμοστάτης βρίσκεται εντός του εύρους λειτουργίας. Διακοπή ρεύματος ή έχει ενεργοποιηθεί ασφάλεια στο κύκλωμα
Οσμές	Τα τρόφιμα με έντονη οσμή, θα πρέπει να τυλιγούνται επαρκώς. Ελέγξτε μήπως υπάρχει χαλασμένο τρόφιμο. Ελέγξτε μήπως το εσωτερικό του ψυγείου χρειάζεται καθαρισμό.
Μέσα στον θάλαμο ψύξης υπάρχουν τρόφιμα που έχουν παγώσει	Ελέγξτε αν ο θερμοστάτης είναι κατάλληλα ρυθμισμένος. Ελέγξτε αν έχει διαρρεύσει νερό από τρόφιμα στο γυάλινο μέρος.
Ο συμπιεστής λειτουργεί συνεχώς	Κατά τη διάρκεια του καλοκαιριού είναι φυσιολογικό ο συμπιεστής να λειτουργεί περισσότερο λόγω της υψηλότερης θερμοκρασίας περιβάλλοντος. Μην τοποθετείτε πολλά τρόφιμα στο ψυγείο. Μην τοποθετείτε στο ψυγείο ζεστά τρόφιμα. Μην ανοίγετε συχνά την πόρτα του καταψύκτη. Έχει δημιουργηθεί παχύ στρώμα πάγου (χρειάζεται απόψυξη).
Η ενδυκτική λυχνία δεν ανάβει	Ελέγξτε εάν το ψυγείο είναι συνδεδεμένος με την παροχή ρεύματος ή αν η ενδεικτική λυχνία έχει καεί.
Η πόρτα του ψυγείου δεν κλείνει σωστά.	Η πόρτα έχει φράξει από συσκευασίες τροφίμων. Υπάρχει υπερβολική ποσότητα τροφίμων. Το ψυγείο γέρνει.
Δυνατοί θόρυβοι	Ελέγξτε εάν τα τρόφιμα έχουν τοποθετηθεί σωστά. Ελέγξτε εάν το ψυγείο είναι σε επίπεδο έδαφος Ελέγξτε αν τα επιμέρους εξαρτήματα έχουν τοποθετηθεί σωστά.

Συμβουλές:

- ◆ Μπορεί να εκλύεται θερμότητα από το ψυγείο κατά τη λειτουργία ειδικά το καλοκαίρι. Οφείλεται στην εκπομπή θερμότητας του συμπυκνωτή και είναι φυσιολογικό.
- ◆ Συμπυκνώματα: Όταν υπάρχει υψηλή σχετική υγρασία μπορεί να εμφανιστούν συμπυκνώματα στην εξωτερική επιφάνεια και στην πόρτα. Είναι φυσιολογικό και μπορείτε απλά να τα απομακρύνετε με ένα στεγνό πανί.
- ◆ Ήχος ροής: Το ψυκτικό υγρό όταν ρέει στο ψυκτικό κύκλωμα παράγει έναν θόρυβο, ο οποίος είναι φυσιολογικός και δεν επηρεάζει την ψυκτική απόδοση.
- ◆ Κατά την ενεργοποίηση και απενεργοποίηση του συμπιεστή αλλά και κατά τη λειτουργία θα ακούγεται ένας συνεχόμενος ήχος.
- ◆ Ήχος κρότου: Η ηλεκτρομαγνητική βαλβίδα ή ο ηλεκτρικός διακόπτης παράγουν έναν ήχο σαν κρότο ο οποίος είναι φυσιολογικός και δεν επηρεάζει τη λειτουργία.

Οδηγίες τοποθέτησης της πόρτας δεξιά και αριστερά

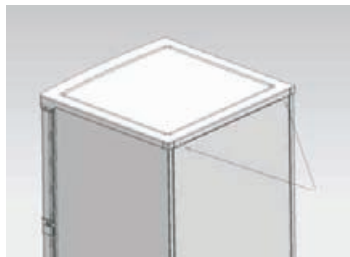

1. Αφαιρέστε τις 2 βίδες που βρίσκονται στο πάνω κάλυμα και αφαιρέστε το.

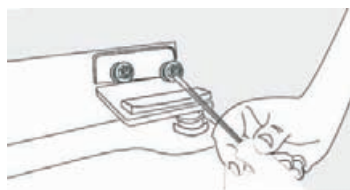

2. Αφαιρέστε τις 2 βίδες που βρίσκονται πάνω στον μεντεσέ



3. Αφαιρέστε την πόρτα



4. Αφαιρέστε τις 2 βίδες για να αφαιρέσετε τον μεντεσέ και αφαιρέστε την πόρτα.

Οδηγίες τοποθέτησης της πόρτας δεξιά και αριστερά

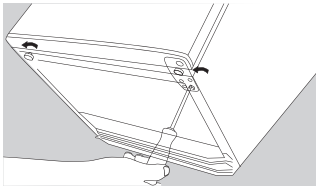

5. Ξεβιδώστε τις βίδες και αφαιρέστε τον βραχίονα του μεντεσέ από τη βάση. Μπορεί να χρειαστεί γαλλικό κλειδί για να χαλαρώσετε τις βίδες. Αφαιρέστε την ακίδα του μεντεσέ και τοποθετήστε την στην απέναντι πλευρά.

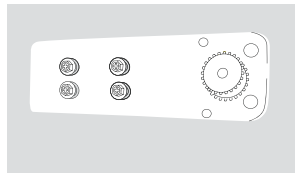

Μετακινήστε τις βίδες και την βάση από την αντίθετη πλευρά και τοποθετήστε τις στο σημείο που βρισκόταν ο μεντεσές.

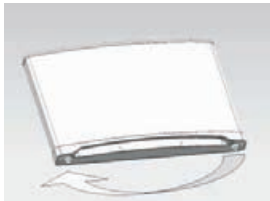

6. Θα γίνει αλλαγή και στο κάτω μέρος της πόρτας από την μια πλευρά στην άλλη.

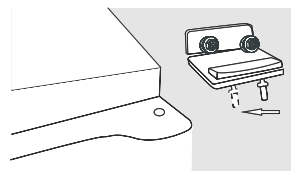

7. Αφαιρέστε την ακίδα της δεξιάς οπής στον πάνω μεντεσέ και τοποθετήστε τη στην αριστερή οπή, όπως δείχνει το βέλος.

8. Αφαιρέστε το κυλινδρικό κάλυμα από την πλευρά που έγινε η αλλαγή και τοποθετήστε το στην άλλη.

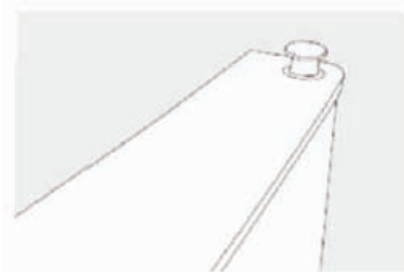

Οδηγίες τοποθέτησης της πόρτας δεξιά και αριστερά

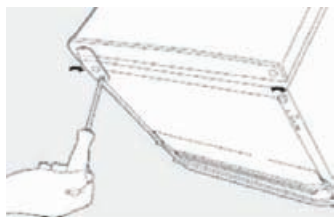

9. Τοποθετήστε τον μεντεσέ στην άλλη πλευρά και σφίξτε τη βίδα



10. Τοποθετήστε τον μεντεσέ της πόρτας και σφίξτε τις βίδες



11. Τοποθετήστε την πόρτα και τον μεντεσέ και σφίξτε τις βίδες

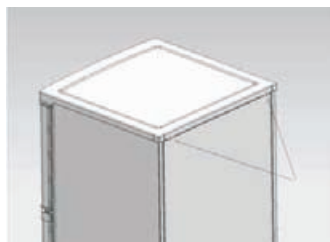

12. Τοποθετήστε το κάλυμα

■ Avertismente privind siguranța	
Semnificația simbolurilor de avertizare de siguranță	2
Avertismente legate de utilizare	2
Avertismente legate de alimentarea la energia electrică	2
Avertismente legate de introducerea elementelor	3
Avertismente legate de reciclare	3
■ Utilizarea corectă a frigiderului	
Denumirea componentelor	4
Tavă de gheață (opțional)	5
Termostat	5
Iluminare lampă și înlocuire	5
Plasare	5
Punerea în funcțiune	5
■ Întreținerea frigiderului	
Igienizarea	6
Dezghetarea	6
Neutilizarea frigiderului	6
■ Întrebări frecvente	
■ Instalarea și schimbarea stânga/dreapta a ușilor	

STIMATE CLIENT:

Vă mulțumim pentru achiziționarea acestui frigider-congelator. Pentru a vă asigura că veți obține cele mai bune rezultate de la noul dumneavoastră frigider-congelator, vă rugăm să acordați câteva minute pentru a citi acest manual.

Asigurați-vă că ambalajele acestui produs sunt eliminate în conformitate cu cerințele actuale de mediu.

Atunci când aruncați orice echipament frigider-congelator, vă rugăm să contactați firma locală ce se ocupă de eliminarea în condiții de siguranță a deșeurilor.

Acest aparat trebuie folosit numai în scopul pentru care a fost creat.

Măsurile de siguranță

► Înțelesul simbolurilor de avertizare



Semn interzis

Acest simbol indică interzicerea unor acțiuni. Nerespectarea lor poate provoca daune produsului sau rănirea persoanelor ce îl folosesc.



Semn de avertizare

Acest simbol indică acțiuni ce trebuie respectate întocmai. Nerespectarea acestor instrucțiuni poate provoca daune produsului sau persoanelor ce îl folosesc.



Semn pentru
precizări

Acest simbol indică acțiuni ce solicită o atenție specială și trebuie luate în considerare. Acestea trebuie luate în seamă pentru a evita riscul de daune ale produsului sau rănirea persoanelor ce folosesc acest produs.

ATENȚIE:

Acest aparat nu este destinat a fi utilizat de minori sau persoane infirme nesupravegheate.

Minorii trebuie supravegheați pentru a vă asigura că nu se joacă cu aparatul.

Acest aparat poate fi folosit de copii cu vârste peste 8 ani și de persoane cu capacități fizice, senzoriale sau mentale reduse sau lipsă de experiență și cunoștințe numai în cazul în care acestea au fost supravegheate și instruite cu privire la utilizarea acestui aparat într-un mod sigur și să înțeleagă pericolele ce pot apărea. Copii nu au voie să se joace cu acest aparat. Întreținerea și igienizarea frigiderului nu se face de către copii fără supraveghere.

GENERAL:

Acest tip de frigider este folosit în hoteluri, birouri, cămine studențești și locuințe. Este folosit cu precădere pentru păstrarea alimentelor, fructelor și băuturilor. Acest frigider are dimensiuni reduse, un consum redus de energie și ușor de folosit.

Acest manual conține informații importante de siguranță pentru consumatorul final.

Avertismente privind siguranța

► Avertismente legate de alimentarea la energia electrică

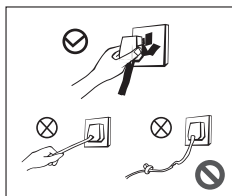

- Nu trageți de cablul de alimentare atunci când doriți să deconectați de la priză. Vă rugăm să apucați ferm ștecherul pentru a scoate din priză aparatul
- Nu deteriorați cablul de alimentare sub nici o formă. Nu utilizați frigiderul atunci când cablul de alimentare este deteriorat sau înădit
- Cablul de alimentare uzat sau deteriorat se înlocuiește de persoane autorizate

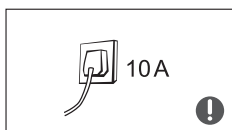

- Vă rugăm să folosiți o priză dedicată, care este de 10A sau mai mult, iar alimentarea să se facă fără a împărți priză cu alte aparate
- Cablul de alimentare trebuie să fie ferm în contact cu prize pentru a evita apariția unor incendii. Asigurați-vă că electrodul de împământare din priză este echipat cu o linie de împământare de încredere.



- Frigiderul adoptă o putere de 220V-240V/50Hz AC, fluctuațiile de tensiune în intervalul de 187 ~ 242V vor cauza defecțiuni sau chiar daune, astfel încât un regulator automat de tensiune de 750 W trebuie să fie instalat în concert cu puterea de curent alternativ
- În cazul apariției scurgerilor de gaz sau a altor gaze inflamabile vă rugăm în primul rând să opriți robinetul de gaz și apoi să deschideți ușile și ferestrele. Nu deconectați frigiderul sau alte aparate electrice pentru că pot provoca scânteii ce pot duce la apariția de incendii.

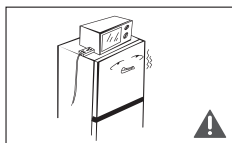

- Pentru a asigura siguranța, nu se recomandă ca deasupra sau în interiorul frigiderului să puneți alte aparate electrice de orice fel

► Avertismente legate de utilizare

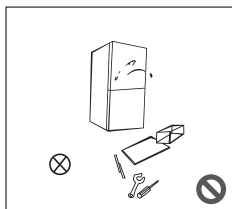

- Reciclarea sau repararea acestui frigider se face exclusiv de personal autorizat. Deteriorarea traseului agentului frigorific, repararea și întreținerea frigiderului trebuie să fie efectuate de către profesioniști
- Cablu de alimentare deteriorat trebuie să fie înlocuit de personal autorizat de către producător, cu scopul de a evita daune produsului sau persoanelor ce folosesc produsul

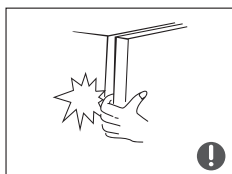

- Mențineți în jurul aparatului o distanță astfel încât să se poată menține o bună ventilație
- Distanțele dintre ușile frigiderului sunt mici. Pentru a preveni rănirea, nu introduceți degetele în aceste locuri. Vă rugăm închideți ușile cu grijă pentru a evita dărâmarea articolelor din interiorul frigiderului
- Nu luați alimente sau recipiente din congelator atunci când frigiderul este în ciclul de răcire, în special containere de metal, în scopul de a evita degerături

Avertismente privind siguranța



- Nu lăsați copiii să intre sau să se urce pe frigider, pentru a preveni blocarea în interiorul frigiderului sau rănirea prin răsturnarea frigiderului
- Nu pulverizați sau spălați frigiderul cu substanțe ce pot ataca suprafața. Nu stropiți aparatul cu lichide din abundență pentru a evita deteriorarea părților electrice ale frigiderului

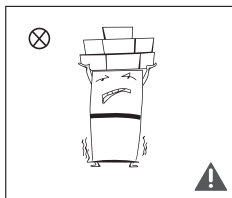

- Nu așezați obiecte grele pe partea de sus a frigiderului deoarece acestea pot cădea la deschiderea ușilor și pot provoca leziuni persoanelor ce folosesc produsul
- Vă rugăm să trageți ștecherul din priză în cazul întreruperilor de energie electrică sau în momentul igienizării aparatului. La reconectare la rețea, așteptați de fiecare dată 5 minute pentru a evita deteriorarea compresorului prin porniri succesive

► Avertismente legate de introducerea elementelor



- Nu puneți obiecte inflamabile, explozive, volatile și extrem de corozive în frigider, pentru a preveni daune produse de incendiu
- Nu așezați obiecte inflamabile lângă frigider pentru a evita incendiile

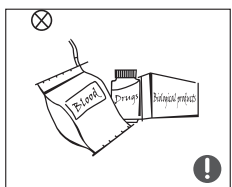

- Acest produs este un frigider de uz casnic și este destinat doar pentru depozitarea produselor alimentare. În conformitate cu standardele naționale, frigiderul de uz casnic nu vor fi utilizate în alte scopuri, cum ar fi stocarea de sânge, medicamente sau produse biologice

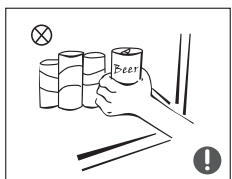

- Nu așezați produse, cum ar fi cutii de bere sau răcoritoare, în congelator pentru a preveni exploziile și alte daune

► Avertismente legate de reciclare



Agent frigorific R600a și spumă ciclopentan sunt materiale combustibile iar frigiderul aruncat trebuie izolat de surse de foc și nu sub nicio formă ars. Vă rugăm să predați frigiderul firmelor de reciclare profesională pentru procesare, pentru a evita daune aduse mediului sau alte pericole



Vă rugăm să fixați bine ușa frigiderului și rafturile să fie plasate în mod corespunzător pentru a evita accidentele de copii care intră și se joacă în frigider

AVERTIZARE



Atenție: risc de incendiu

RECOMANDĂRI:

AVERTISMENT Păstrați orificiile de ventilație, eliminați orice obstrucționare a ventilației în jurul frigiderului.

ATENȚIE Nu deteriorați circuitul agentului frigorific

AVERTISMENT Nu utilizați aparate electrice în interiorul compartimentelor de depozitare a alimentelor frigiderului, cu excepția cazului în care sunt de tipul recomandat de producător.

Aparatul trebuie să fie deconectat de la priză dacă nu este folosit sau înainte de igienizare

Acest aparat nu este destinat utilizării de către persoane (inclusiv copii) cu abilități fizice, senzoriale sau capacități mentale, sau lipsa de experiență și cunoștințe, cu excepția cazului în care acestea au fost supravegheate sau instruite cu privire la utilizarea aparatului de către o persoană responsabilă pentru siguranța lor.

Copiii trebuie supravegheați pentru a vă asigura că nu se joacă cu aparatul

În cazul în care cablul de alimentare este deteriorat, acesta trebuie înlocuit de către producător, agentul său de service sau persoane calificate pentru a evita un pericol

Vă rugăm să reciclați frigiderul-congelator în conformitate cu reglementare locale pentru utilizarea de gaze inflamabile și de agent frigorific

Vă rugăm să respectați reglementările locale privind recilcarea aparatului cu agent frigorific

inflamabil și gaz sub presiune. Înainte de a recicla aparatul, vă rugăm să demontați ușile pentru a preveni accidentele.



Reciclarea corectă a acestui produs

Acest marcaj indică faptul că acest produs nu trebuie aruncat împreună cu alte deșeuri de uz casnic pe întreg teritoriul UE. Pentru a preveni posibile efecte dăunătoare asupra mediului sau sănătății umane de la aruncarea necontrolată a deșeurilor, reciclați în mod responsabil pentru a promova refolosirea resurse de materiale. Pentru a returna produsul utilizat, vă rugăm să folosiți sistemul de colectare sau contactați magazinul de unde a fost achiziționat produsul. Ei pot lua acest produs pentru reciclare în condiții de siguranță a mediului.

Utilizarea corectă a frigiderului

► Denumirea componentelor

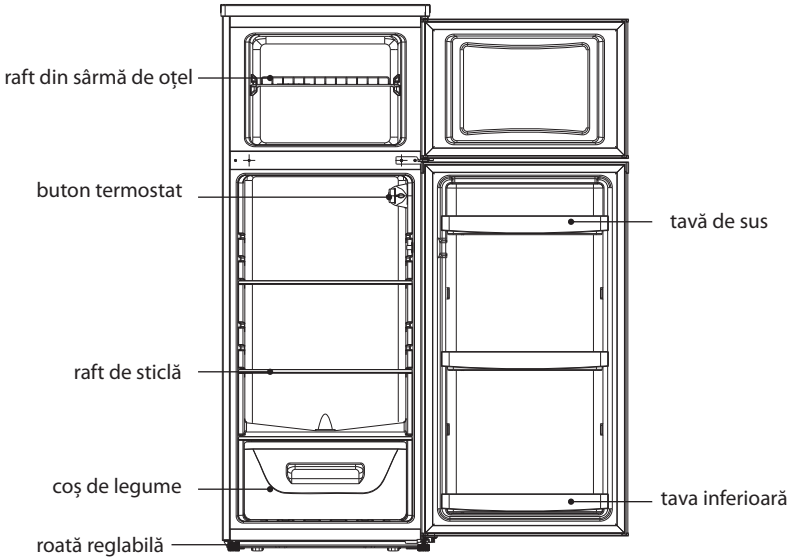

Camera de răcier

- Camera de răcire este adecvată pentru a depozita o varietate de fructe, legume, băuturi și alte alimente consumate pe termen scurt
- Produsele alimentare gătite nu trebuie să fie puse în camera de răcire până când acestea nu s-au răcit până la temperatura camerei
- Se recomandă ca alimentele să fie sigilate/resigilate înainte de a fi puse în frigider
- Rafturile de sticlă pot fi ajustate în sus sau în jos pentru o spațiu rezonabil de stocare și utilizare ușoară

Camera de congelare

- Temperatura scăzută în camera de congelare poate păstra alimente proaspete pentru o lungă perioadă de timp și este utilizat în principal pentru a stoca alimente congelate și de a face gheață
- Camera de congelare este potrivită pentru depozita carne, pește, creveți, găluște, bile de orez și alte alimente ce nu pot fi consumate în termen scurt
- Bucățile mari de carne trebuie, de preferință, să fie împărțite în bucăți mici, pentru un acces facil. Vă rugăm să marcați și termenul de valabilitate pentru a evita consumul de produse expirate



Caracteristicile și accesoriile frigiderului cumpărat poate varia cu legenda, vă rugăm în acest caz să consultați lista de ambalare

Utilizarea corectă a frigiderului

► Utilizarea corectă a frigiderului

Tavă de gheață (opțional)

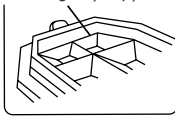

- Tava de gheață este folosită pentru a face gheață. Apă fiartă se pune în tava specială iar apoi se păstrează în congelator pentru câteva ore până când acestea se transformă în gheață, apoi prin răscuire bucățile de gheață se vor desprinde de tavă.
- Pentru a evita ruperea, nu îndoiți tava de gheață

► Termostat

- Butonul selector de temperatură se află pe peretele lateral dreapta a interiorului frigiderului
Poziția "Off": Frigider oprit
Poziția "Min": Răcire minimă
Poziția "Med": Răcire normal (cel mai frecvent folosit)
Poziția "Max": Răcire maximă
- În timpul temperaturii ambientale ridicate, de exemplu în zilele fierbinți de vară, poate fi necesar să se folosească pentru termostat poziția Max, cea mai rece, astfel încât temperatura în frigider să fie adecvată. Acest lucru poate cauza funcționarea continuă a compresorului
La prima pornire a frigiderului, setați butonul termostatului la "Med".
- Așteptați ca frigiderul să se răcească complet înainte de a adăuga alimente. Înainte de a adăuga alimente, cel mai bun timp de așteptare sunt 24 de ore de la pornirea frigiderului. Butonul termostatului controlează temperatura. Când butonul de control al termostatului este setat pe OFF, frigider nu va funcționa.

► Iluminare lampă și înlocuire

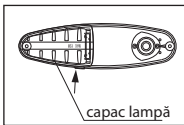

- Parametrii lampă de iluminat: MAX15W
Înlocuirea lămpii interioare:
Întâi scoateți ștecherul din priză.
După cum se specifică în desen, mai întâi scoateți capacul lămpii, și apoi înlocuiți becul.

► Amplasarea frigiderului

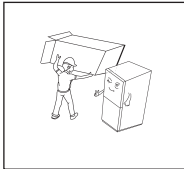

- Înainte de a utiliza frigiderul, scoateți toate materialele de ambalare inclusiv partea de jos și tamponașele de spumă și benzile interioare din frigider, rupeți peliculă protectoare de pe ușa și de pe corpul frigiderului.

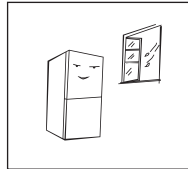

- Frigiderul este plasat într-o cameră bine ventilată; suprafața să fie plată și robustă (ajustați prin rotirea la stânga sau la dreapta până când frigiderul este stabil).

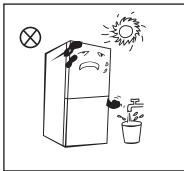

- Țineți frigiderul departe de căldură și ferit de razele soarelui. Nu plasați frigiderul în camera cu umezeală ridicată pentru a preveni rugină sau reducerea efectului izolant al suprafeței frigiderului.

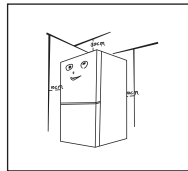

- Spațiul de deasupra frigiderului
Trebuie să fie mai mare de 30 cm, iar distanțele laterale și din spate mai mare de 10 cm pentru a facilita deschiderea și de închidere și de disiparea căldurii.
- Ștergeți frigiderul la interior și Exterior cu o cârpă umedă (adăugați o cantitate mică de detergent în apa caldă și ștergeți apoi cu o cârpă umedă; la final folosiți o cârpă umedă fără detergent).

► Start

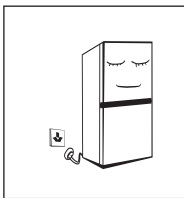

- La prima pornire, frigiderul va rămâne pentru o jumătate de oră la temperatura camerei înainte de a conecta ștecherul la priză 220-240V/50Hz.
- Frigiderul va funcționa 2-3 ore înainte de a încălca alimente proaspete sau congelate; frigider va funcționa pentru mai mult de 4 ore vara, având în vedere că temperatura ambiantă este mare.

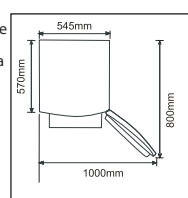

- Va rugăm să lăsați suficient spațiu pentru a asigura deschiderea optimă și îndepărtarea sarterului.
- Dimensiunile prezentate sunt numai pentru referință

Întreținerea frigiderului

► Igienizare

- Praful din spatele și de sub frigider trebuie curățat frecvent pentru a îmbunătăți efectul de răcire și de a economisi energia. Interiorul frigiderului ar trebui să fie curățat în mod regulat, pentru a evita mirosul. Pentru curățare se recomanda prosoape moi sau un burete, iar detergentii să fie non-corozivi. Congelatorul se va curăța cu apă curată și o cârpă uscată. Lăsați ușile deschise pentru o uscare naturală înainte ca aparatul să fie pornit



- Pentru curățarea frigiderului nu utilizați perii dure, bile de oțel, perii de sârmă, abrazive, cum ar fi paste de dinți, solvenți organici (cum ar fi alcool, acetonă, etc.), apă fierbinte, acid sau elemente alcaline, având în vedere că acest lucru poate deteriora suprafața frigiderului atât la interior cât și la exterior.
- Nu clătiți cu apă din abundență, astfel încât să nu afecteze izolarea electrică. Vă rugăm să folosiți o cârpă uscată pentru curățarea lămpii de iluminat, butonul de control al temperaturii și componente electrice.



Vă rugăm să scoateți frigiderul din priză pentru dezghețare și curățare

► Dezghețarea

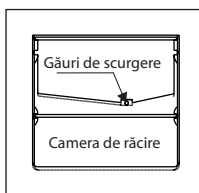

- Nu este nevoie de decongelarea manuală a frigiderului. Gheața de pe peretele posterior se va topi și va ieși prin orificiile de drenaj în frigider pe parcursul zilei și se va evapora automat
- Camera de congelare trebuie să fie decongelată manual. Un strat de gheață se va forma pe placa evaporatorului după o perioadă de timp de funcționare. Dacă stratul de gheață este prea gros, consumul de energie va fi crescut și efectul de răcire va fi afectat, fiind necesare dezghețarea și curățarea sunt Vă rog să plasați un bol de apă caldă în camera de congelare pentru a accelera decongelarea, și apa rezultată din dezghețare va fi strânsă cu o cârpă uscată.



Nu folosiți ustensile metalice sau încălzitor electric pentru dezghețare, pentru a nu deteriora aparatul. Înainte de a scoate sertare și alte accesorii, scoateți alimentele și lăsați-le într-un loc răcoros până când decongețați frigiderul

► Neutilizarea frigiderului

Alimentele pot fi păstrate pentru câteva ore, chiar și în timpul verii, în caz de pană de curent, însă se recomandă reducerea frecvenței de deschidere a ușii și punerea de alimente proaspete în congelator

Vă rugăm să scoateți frigiderul din priză dacă nu este utilizat o perioadă lungă de timp sau pentru curățare. Țineți ușa deschisă pentru a se evita mirosul neplăcut

Înainte de a muta frigiderul, vă rugăm să eliminați toate elementele din frigider și să fixați sticlele cu paravane, cutiile de fructe și legume, sertarele congelatorului cu banda astfel încât ușa să nu se deschidă în timpul deplasării. Nu întoarceți frigiderul invers, să nu fie răsturnat pe orizontală sau zdrocnit, să nu fie înclinat mai mult de 45 grade



Se recomandă funcționarea continuă la pornirea frigiderului. Vă rugăm să nu vă mișcați des frigiderul din poziția lui normală, astfel încât să nu afecteze durata de viață a frigiderului.

Întrebări frecvente

- Următoarele aspecte simple pot fi manipulate de către utilizator. Vă rugăm să sunați serviciul post-vânzare în cazul în care problemele nu sunt rezolvate

Frigiderul nu pornește	Dacă frigiderul este sau nu conectat la priză; Tensiunea este scăzută; Circuit interrupt sau scurt-circuitat
Miros neplăcut	Alimente mirositoare ar trebui sigilate/acoperite; Alimentele sunt alterate; Dacă interiorul trebuie să fie curățat
Alimentele din frigider sunt înghețate	Dacă termostatul este pe o poziție prea mare; Alimentele care conțin apă se pun în interiorul paravanului de sticlă.
Funcționarea pe termen lung a compresorului	Este normal ca frigiderul să opereze mai mult timp în Perioada verii când temperatura ambientală este ridicată; Nu puneți prea multe alimente în frigider, la un moment dat; Nu puneți alimente fierbinți în frigider până când acestea nu sunt la temperatura camerei; Deschiderea frecventă a ușii frigiderului. Strat gros de gheață (este nevoie de decongelare).
Nu funcționează lampa din interior	Dacă frigiderul este conectat la priză, dacă becul interior nu este ars.
Ușa frigiderului nu poate fi închisă în mod corespunzător	Ușa frigiderului este blocată de pachete cu produse alimentare; Prea multă mâncare în interiorul frigiderului; Reglați poziția frigiderului.
Zgomote puternice	Dacă alimentele sunt corect așezate, dacă frigiderul este echilibrat; Dacă părțile frigiderului sunt plasate în mod corespunzător

NOTE:

- ◆ Din spatele frigiderului se emite căldură în timpul funcționării în special în timpul verii, acest lucru este cauzat de radiația condensatorului, iar fiind un fenomen normal.
- ◆ Condensul: fenomenul de condensare va fi detectat pe suprafața exterioară și ușa interioară a congelatorului, atunci când umiditatea mediului ambiant este mare, acest lucru este un fenomen normal, iar condensul pot fi șters cu un prosop uscat.
- ◆ Sunet debit de aer: agenții frigorifici care circulă în traseele de agent frigorific vor produce un sunet care este normal și nu afectează efectul de răcire.
- ◆ Un zgomot ciudat va fi generat prin pornirea compresorului în special atunci când acesta pornește și oprește cilul de racier
- ◆ Zăngănit: Supapa electrovalvei sau întrerupătorul electric va emite un zgomot, care este un fenomen normal și nu afectează funcționarea.
- ◆ Camera de răcire va îngheța periodic și dezgheța (picături de apă vor fi generate pe partea din spate a camerei frigorifice când decongeleți), care sunt normale

Instalarea și schimbarea stânga/dreapta a ușilor

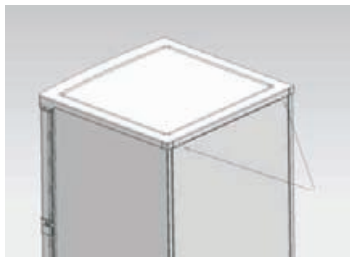

1. Scoateți cele două capace și înlăturați capacul superior.

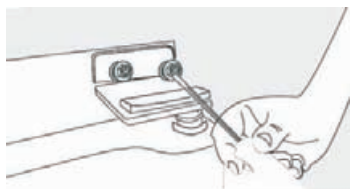

2. Scoateți cele 2 șuruburi fixate pe balama

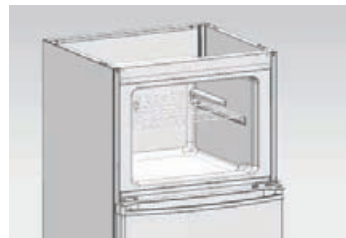

3. Scoateți ușa



4. Deșurubați balamaua fixă, scoateți ușa.

Instalarea și schimbarea stânga/dreapta a ușilor

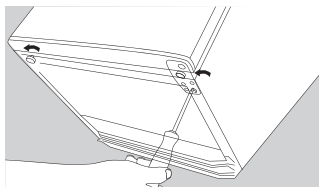

5. Desfaceți șuruburile și scoateți suportul balamalei din bază. O cheie poate fi necesară pentru a slăbi șuruburile. Scoateți balama și re-poziționați-o în locația pe partea opusă

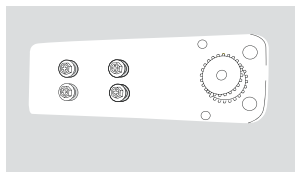

Scoateți șuruburile și piciorul reglabil din partea opusă și fixați-le înapoi unde au fost pe suportul balamalei.

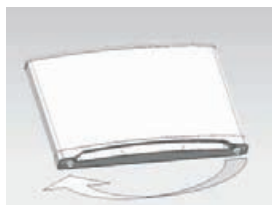

6. Va veni sub prag, o schimbare de la o parte în cealaltă parte.

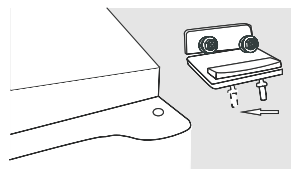

7. Desfaceți șurubul de la gaura dreaptă sus și fixați-l la gaura din stânga, așa cum este indicat de săgeată

8. Manșonul ușii va fi de pe partea inițială pe partea cealaltă

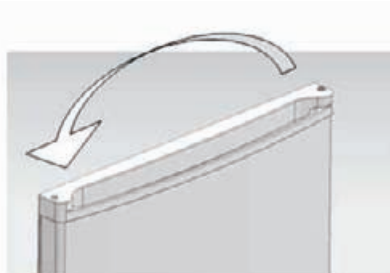
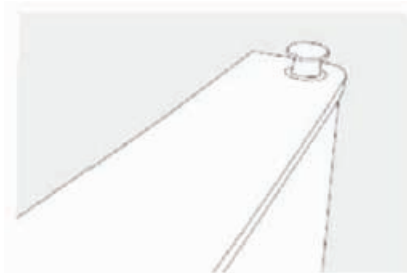

Instalarea și schimbarea stânga/dreapta a ușiiilor

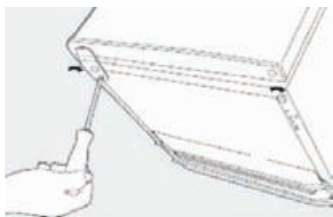

9. Instalați balamaua în partea de jos, strângând șuruburile



10. Instalați balamaua și fixați cu șuruburi.



11. Instalați ușa și balamaua cu șuruburi.



12. Instalați capacul.

